

## TYPICAL SPECIFICATIONS

Frequency Response	XLR Input to any Output.....	+0/-0.5dB, 20Hz - 20kHz
T.H.D. and Noise	All measurements at +10dBu.....	<0.006% @ 1kHz
	XLR In to Direct Out.....	<0.01% @ 10kHz
	XLR In to Mix Out.....	<0.006% @ 1kHz
	.....	<0.01% @ 10kHz
Mic Input E.I.N.	22Hz-22kHz bandwidth, unweighted .....	<-128dBu (150Ω source)
Residual Noise	Mix Output; no inputs routed, Mix fader @ 0dB .....	-90dB
Bus Noise	Mix Output; 48 channels routed, input faders @ -∞, Mix fader 0dB .....	<-84dBu
	Grp Output; 48 channels routed, input faders @ -∞, Grp fader 0dB .....	<-84dBu
	Aux Output; 48 channels routed, input sends @ -∞, Grp fader 0dB.....	<-85dBu
	.....	
Crosstalk	1kHz, +20dBu input signals	
	Input Channel muting.....	>102dB
	Input fader cutoff .....	>100dB
	Input pan pot isolation .....	>60dB
	Mix routing isolation .....	>102dB
	Group routing isolation .....	>88dB
	Group-group crosstalk.....	<-90dB
	Group-Mix crosstalk .....	<-90dB
	Mix-group crosstalk .....	<-95dB
	Aux send off.....	<-93dB
CMRR	Mono input .....	-85dB @ 1kHz
Input & Output Levels	Mic Input .....	+26dBu max.
	Balanced Inputs.....	+21dBu max.
	Balanced Outputs .....	+21dBu max.
	Nominal Operating Level.....	0dBu
Input & Output Impedances	Mic Input .....	2kΩ
	All other Inputs.....	>10kΩ
	Headphone Output.....	50Ω
	All other Outputs .....	<75Ω
Oscillator	63Hz to 10kHz/Pink Noise, variable level	
HP Filter (Mono Input)	30-400Hz, 12dB/octave	
EQ (Mono Input)	HF .....	1.2kHz - 20kHz, ±15dB, shelving
	Hi-Mid .....	750Hz - 12kHz, ±15dB, Q=0.5 - 3.0
	Lo-Mid.....	75Hz - 1.2kHz, ±15dB, Q=0.5 - 3.0
	LF .....	35Hz - 550Hz, ±15dB, shelving
Metering	Overbridge, 8 VU Meters monitoring Group/Aux/Matrix,	
	+ 3 VU Meters monitoring Left Mix/AFL/PFL, Right Mix/AFL/PFL & Mono (centre) Mix	
	Each meter has a peak LED set to 3dB below clipping	
	Mono & Stereo Inputs, 12-LED bargraph + Peak LED	
Power Consumption	48 Ch Console, each 17V rail takes 6.5A (nominal)(measured without Littlites connected)	
	The 8V rail takes 0.5A (nominal)	
Operating conditions	Temperature Range.....	-10°C to +30°C
	Relative Humidity.....	0% to 80%

Note: These figures are typical of performance in a normal electromagnetic environment. Performance may be degraded in severe conditions. All measurements refer to electronically balanced inputs and outputs with VCAs enabled. Input and output transformers may affect these specifications.



Soundcraft Registered Community Trade Mark/RTM No. 000557827

**SOUNDCRAFT**  
HARMAN INTERNATIONAL INDUSTRIES LTD  
CRANBORNE HOUSE, CRANBORNE ROAD  
POTTERS BAR, HERTS, EN6 3JN, UK  
TEL: +44 (0)1707 665000  
FAX: +44 (0)1707 660742  
EMAIL: info@soundcraft.com

**SOUNDCRAFT USA**  
8500 BALBOA BLVD.,  
NORTHRIDGE, CA 91329, USA  
TEL: +1-818-920-3212  
FAX: +1-818-920-3208  
EMAIL: soundcraft-usa@harman.com

[www.soundcraft.com](http://www.soundcraft.com)

Soundcraft reserves the right to improve or otherwise alter any information supplied in this document or any other documentation supplied hereafter. E&OE 01/04  
This equipment complies with the EMC Directive 89/336/EEC

Part No: ZL0604



H A Harman International Company



LIVE PERFORMANCE CONSOLE



**Dual-purpose.  
Totally modular.  
And equipped to handle  
16 separate monitor mixes.**



# Dual-purpose. Totally modular. And equipped to handle 16 separate monitor mixes.

# MH4

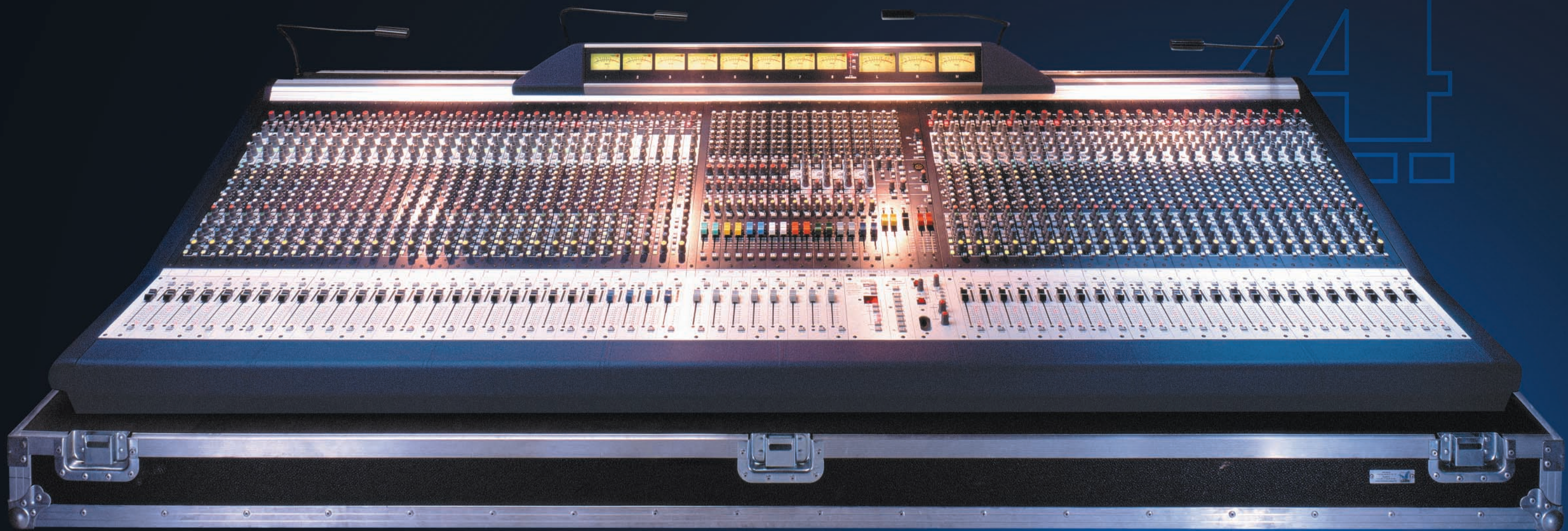

In the modern world, live sound mixing demands a level of versatility way beyond anything previously imagined. Sound contractors and venues alike must maximise their inventory investments to accommodate a wide variety of different events. However mixing consoles designed for use in both Front-of-house and Monitor positions have always been a compromise, with the all-important Group and Auxiliary bus structures presenting a daunting learning curve.

The Soundcraft MH4 changes all that. With external styling every bit as innovative as its internal design, the MH4 delivers an intuitive, uncomplicated and sonically superior mixing solution for engineers working on concert tours, the performing arts, theatre productions and corporate events.

In short, the Soundcraft MH4 is ready for anything.

## Key Features

- Dual-purpose live console: FOH, Monitors, or Monitors from FOH
- Totally modular for flexible layouts
- Frame sizes 24 mono/4 stereo, 32 mono/4 stereo, 40 mono/4 stereo, 48 mono/4 stereo, 56 mono/4 stereo
- Completely flexible Auxiliary Bus structure with up to four stereo sends for in-ear monitoring

- 8 group busses and 12 aux busses in FOH mode
- 16 monitor busses (configurable as 16 mono, 12 mono/2 stereo, 8 mono/4 stereo) in Monitor mode
- All Aux outputs under fader control
- Integral 20x8 matrix
- Semi-parametric EQ on stereo aux outputs
- Integral Clearcom™ compatible talkback system

- New Mic Amp design with high headroom and outstanding CMRR
- New EQ design with focused response
- LCR panning on inputs
- 8 VCA groups and 8 Mute groups with snapshot automation and MIDI control
- Passive mic splitter outputs from each channel

- Integrated control of BSS Audio Varicurve™ and dbx DriveRack™
- Optional bargraph output meterbridge



# Ready to go anywhere

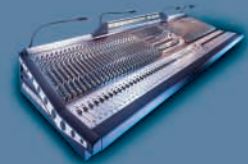

## CLUB: Cubby Bear Club, USA

As part of a complete system upgrade, Ideal Productions have supplied Chicago's Cubby Bear club with two MH4 consoles to handle front-of-house and monitor mixing.

"Intuitive ease of use was the first thing that attracted us to the MH4. It's well laid out and elegant in its simplicity. It's also very flexible, admirably functioning as either a front-of-house console or dedicated monitor board offering eight separate wedge mixes plus four stereo in-ear mixes."

**Todd Petersen, Owner - Ideal Productions**



## FESTIVAL: Montreux Jazz, Switzerland

An MH4 console performed front-of-house duties at the Montreux Jazz Festival in 2002, and again in 2003.



## RENTAL: Gighire, UK



South London-based Gighire are now into their third MH4 desk - part of a systematic upgrade programme.

"As a mid-sized company we implement an ongoing programme of stock replacement," said Jon Pickett, partner at Gighire. "The MH4's versatility was important to us. In addition, it represents exceptional value and build quality - and it also sounds absolutely great. The EQ has the familiar feel of Soundcraft, and the meters are really accurate."

**Jon Pickett, Partner, Gighire**

## INSTALLATION: Horizon, USA

Horizon Christian Fellowship recently finished a complete upgrade of its sanctuary sound system, which is now capped off with the installation of a Soundcraft MH4 mixing console which provides both front-of-house and monitor mixes for the 700-seat room.

"The MH4 is very intuitive and simple to operate, which is important in an environment like this where volunteers often have to run it. When you mute a channel, everything's muted - you don't have to worry about double-checking your auxes, and the board is also nice and quiet, not to mention very forgiving."

**Michael Mendoza, Head Audio Engineer, Horizon**



## INSTALLATION: Palladium Palace, Russia

Khabarovsk City in Siberia has opened the Palladium Palace, a substantial entertainment centre which doubles as an ice-rink stadium and a concert hall. In ice-rink mode, the Palace is used for competitions, training, and social ice skating activities. With a few modifications, the venue can be turned into a 7,000-capacity concert hall.

For the main events, when the Palladium Palace is turned into a sizeable concert venue, PAL Systems has provided a portable control system, consisting of a Soundcraft MH4 at front-of-house, a Soundcraft MH3 on monitors, and mobile racks of amplifiers.



## FESTIVAL: Bruck Music, Germany



A revival of Cole Porter's Broadway hit *Anything Goes* at the Musical Festival at Bruck has proved extremely popular. Eventtechnik provided sound reinforcement and invested in a 48-channel MH4 for front-of-house.

Erich Kulicska recalls, "We immediately loved the MH4. It's extremely good value for money and offers all the features and sound quality expected of high-end pro-audio."

**Erich Kulicska, Manager, Eventtechnik**

## CHURCH: Canyon Hills, USA



When Pacific West Sound commenced work on a complete re-structure of the audio system at Canyon Hills Assembly of God Church in Bakersfield, they turned to Soundcraft for a comprehensive mixing solution.

"The MH4 sounds great. Its mic pres are warm and the British EQ is very pleasing to the ear. Console layout is extremely straightforward and after a minimum of training, everyone in the church's audio department was able to capably use the desk. The modular design was another big plus, as was its dual functionality as a front-of-house and monitor mixer. 16 aux's eliminate the need for a dedicated monitor board. All in all, the MH4 is a very cool console."

**Brent Milton, PWS**

## INSTALLATION: Music Bank, UK

Music Bank, London's premier rehearsal facility, has undertaken a major expansion programme resulting in new East and West studios. Designed to attract medium-sized live bands, both studios boast a 40-channel MH4.

"We've got Soundcraft desks (SM20 and SM24) in the South and North Studios," explained Music Bank's Nunu Whiting, "and we've always found them to be very acceptable to the professional engineers." It was this popularity that convinced Music Bank to invest in the MH4 consoles.

**Nunu Whiting, Music Bank**



# Dual-Purpose Flexibility

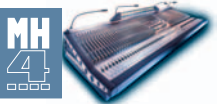

While traditional in its module signal flow layout, the MH4's bus structures have been designed to make the console as user-friendly as possible, while allowing the possibilities of using the desk either at front-of-house or monitor positions. You can even split the functionality in one desk and achieve both FOH and monitor control from one location (such as would be used in regional theatre performance).

The GLOBAL MODE switch on each of the 4 stereo Grp/Aux output modules determines how each pair of Grp/Aux busses behaves when used as FOH groups or Monitor sends.

The first 8 mono aux sends are active in either FOH or Monitor mode, and are routed to the respective aux outputs and controlled by faders.

## FOH Mode

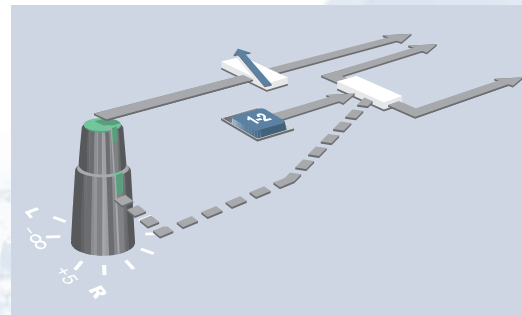

In FOH mode, the console provides 12 mono aux sends and 8 groups, while in Monitor mode there are 16 monitor busses, configurable as 16 mono, 12 mono/2 stereo or 8 mono/4 stereo.

The stereo Grp/Aux sends are very simple to utilise. In FOH mode, each pan control mixes the channel signal to the odd and even groups, selected by familiar push-button routing. This also means that each pair of groups has its own pan control, rather than a single pan deriving all the group image settings in parallel. Four upper level controls now feed another 4 mono aux busses (aux 17-20).

## Monitor Mode

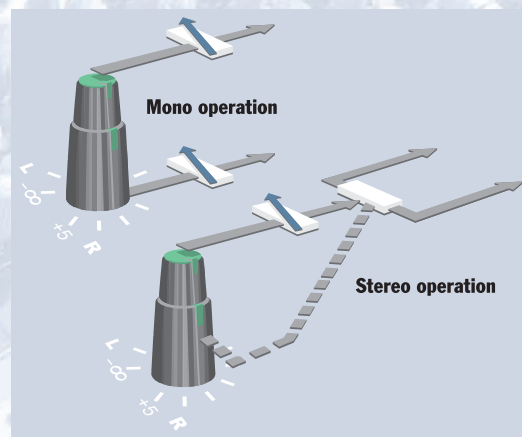

In monitor mode, true mono/stereo switching lets you take maximum advantage of the console's 16 busses, giving configurations of 16 mono, 12 mono/2 stereo and 8 mono/4 stereo auxes. A stereo aux becomes a true stereo monitor send, with level and pan controls for each pair. The 1-2 group routing does not function in this mode.

If stereo Auxes are being used, powerful stereo semi-parametric equaliser sections on the outputs provide major assistance when creating in-ear monitor mixes. All Auxiliary outputs are controlled by 60mm faders, colour-coded to match their corresponding input feeds.

This flexibility is enhanced by the MH4's totally modular construction, which means that you can lay out the console inputs to your own requirements, including positioning the stereo input modules at any location in the desk where you need them to suit the type of incoming signal. This is made simple because each module has an integral connector panel.

With such a variety of stereo sources nowadays, such as effects returns, CD inputs, computer-based WAV files, you often need more stereo inputs than you think - four are included as standard in addition to the full complement of mono inputs.

## Improved signal path performance

The MH4 signal path has been closely examined and optimised for modern live sound applications. As a result the MH4 has a very low noise floor and headroom has been increased.

## True LCR panning

Each module has a stereo pan control, plus an LCR mode switch which provides true LCR panning across the three main outputs.

## Integral matrix to maximise efficiency

In installed sound systems and on corporate events, signals are typically fed through distributed loudspeakers. The MH4's comprehensive 20x8 matrix means that groups, auxes, main outputs and bus injects can all be fed to numerous loudspeaker positions. Each output module features its own matrix feeds.

## Comprehensive VCA and Mute groups

Channels may be assigned to any number of 8 VCA groups for master control, and also to 8 mute groups. The scene changes for the channel mutes and VCA assignments may be controlled by the console's own Scene Control automation, and triggered by external MIDI control systems.

The MUTE button may also be used to trigger an external sampler. For example - as you unmute a channel using a MIDI NOTE command.

## EQ Curves

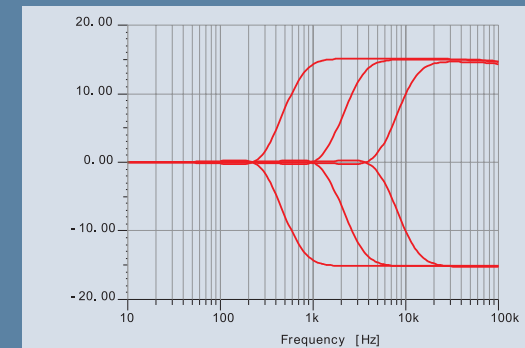
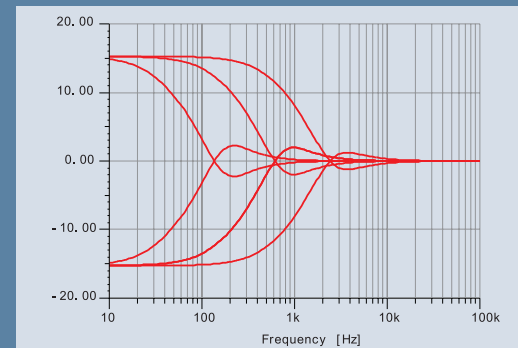

## Mic Preamp & EQ

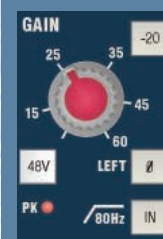

Many modern microphones have the capability to produce high output levels, so we designed our mic pre to be able to handle this, and at the same time improved the CMRR to a noise-defeating 80dB wide band. This means that the console is much less susceptible to interference from lighting lines and stray mains fields.



Soundcraft EQ design has always been revered. The MH4 provides a smoother EQ response that can be more closely focused on individual sounds and instruments. This new design is a result of extensive research carried out with leading sound engineers around the world, and produces a response that is well suited to both smooth sound contouring and tightly focused dynamic optimisation.

## Clearcom™ compatible interface

The desk has an integral comms interface using standard mic and headphone connections, also compatible with the Clearcom™ system.

## Integral mic splits on each module

Each input module has a parallel output feed to act as split for mics from stage to FOH.

## Truly Intelligent console linking

Linking two MH4 consoles (or an MH3 and an MH4) is easy, with just one umbilical cord providing synchronised

## Reliability



In designing a console for today's hectic road-life, we've taken advantage of the technology again to produce a lighter, cooler desk. Thanks to SMD\* technology, we can reduce weight and keep internal temperatures well under control. We estimate that an MH4 is 20% less in weight than similar sized consoles.

We also use the proven Soundcraft CPS800 PSU as used on the well-known SM20 and Series FOUR consoles. Dual redundancy is of course available. The CPS2000 PSU, as used on the Series FIVE, is also available as an extra cost option.

Rest assured that the MH4's modular concept adds to the console's serviceability should anything fail.

\*SMD - Surface Mount Device technology. This employs sub-miniature components and a special soldering process to give reduced size and weight and increased reliability over 'conventional' circuit board technology.

automation and solo functions, plus a standard audio multicore for bus linking. The consoles can even automatically identify the Master/Slave relationship.



## Phantom Power

Phantom power in operation is confirmed by an LED next to each input connector, whether that power is from the console or being received through the input cabling.

# Mono Input Module



## New high performance input pre-amp

This totally new design features a high headroom and outstanding CMRR performance. The XLR input can handle signals up to +26dBu, with a gain range of +15dBu to +60dBu and a 20dB gain change switch. A Peak LED indicates internal signal levels in excess of +18dBu.

Polarity Reverse and Phantom Power switching is provided, with the 48V LED indicating the presence of phantom power on the XLR socket, and it will also illuminate if phantom power is applied via the other end of a multicore. The Split Output XLR carries a parallel passive split from the signal connected to the input XLR, for output to a FOH console if the MH4 is being used in Monitor mode.

## Balanced Insert Points with INS switch

Separate jacks provide a pre or post-EQ (internal switch) balanced send and return, at a nominal level of 0dBu. The INS switch switches the insert return into the signal path. The insert send is always active, even when INS is not on.

## EQ and HI-PASS Filter

This new design retains the traditional Soundcraft response, but sounds even better with steeper slopes on the HF stage focussing the control where you want it, and some carefully tailored overshoot on the LF band, which automatically controls the muddy lower-mid frequencies when boosting lows. The all-important high-pass filter is variable from 30Hz - 400Hz with bypass if required.

The EQ section is four band, with shelving sweep high and low frequency sections, and fully parametric high-mid and low-mid bands. The frequency ranges are 35Hz-550Hz (LF), 75Hz-1.2kHz (Low Mid), 750Hz-12kHz (High Mid), and 1.2kHz-20kHz (HF), with +/-15dB of cut or boost available at any frequency. The Q is variable on the two mid bands from 0.5 to 3.

## Mono Aux Sends

There are 8 dedicated mono Aux sends, these are intended as FX sends in FOH use, or mono mixes for monitoring. Each pair of mono Auxes can be switched Pre- or Post-fader by the adjacent PRE switch. The default Pre-fade signal for all Auxes is Post-EQ but can be changed to Pre-EQ via internal links (both feeds follow the channel mute).

## Direct Output

A balanced direct output XLR is available from the channel, using Aux 8 when switched to DIR. The source is controlled by solder links as follows:

	Solder links	
DIR switch pressed (level control from Aux 8)	pre-EQ (default)	post-EQ
DIR switch not pressed	post-fade (default)	pre-EQ

## Groups and Stereo/Mono switchable Aux sends

The dual-purpose FOH/Monitor capability of the MH4 comes from the way in which the lower bank of Aux sends and Group routing switches can function differently depending on the setting of the GRP global mode switch (located on each of the four Stereo Group modules).

## 'Monitor' Mode - Global GRP mode NOT SELECTED

In this mode the four dual concentric sends function as Aux sends 9-16. These are mono/stereo switchable in banks (A9-A12 & A13-A16). Up to 16 mono auxes can be configured while stereo auxes are ideal for use as In-Ear or stereo wedge sends. The top knob controls level, with a gain of 5dB at maximum, while the lower knob controls Pan, with 3dB centre drop. Sends are switchable Pre or Post fader in banks (A9-A12 & A13-A16), with pre fade signal following the global module links for pre- or post-EQ (default = post-EQ).

## 'FOH' Mode - Global GRP mode SELECTED

In this mode the busses which are used in Monitor mode for Auxes 9-16, now become Subgroup busses, with fixed routing via the 1-2, 3-4, 5-6, 7-8



switches. Note that, unlike a conventional FOH console, the panning to these Groups does not follow the main channel Pan pot, but each pair has its own Pan, using the bottom of the adjacent dual concentric pot. This arrangement is designed to give more flexibility in routing, as even though the Group busses are routed in pairs, it is now possible to route to any individual bus without tying up the main mix bus pan pot.

Alternatively, up to 4 stereo subgroups could be created, each with its own pan settings from the inputs.

As a bonus in FOH mode, the top knobs of the dual concentric pots become an additional 4 mono Aux sends, numbered A17, 18, 19 and 20. These can be used for additional FX sends, and can be switched pre- or post-fader by the PRE switches. The masters for these sends are rotary controls located on the Stereo Group module.

## Mix Bus Routing and Pan controls

The signal is sent to the stereo mix bus and the mono (C) bus using the MIX and C switches (illuminated).

The PAN control, which gives 3dB centre drop, operates on the stereo mix bus signal, unless LCR panning is engaged.

The Mono bus (C) is always fed directly with the post-fader signal, unless LCR panning is engaged.

## LCR Panning

The LCR switch changes the mode of the Pan pot from normal left - right panning with a 3dB centre drop, to 3-way LCR panning, requiring both the mono (C) bus and stereo mix bus to be routed, and the pan pot panning from left to C, and C to right. When the pot is physically centred, there is no output from the left and right mix bus outputs.

## Fader

A high-quality long-throw 100mm fader controls the level to all busses, and has 10dB of gain when fully up as well as an expanded scale around the critical unity gain area for maximum resolution.

## MUTE

The MUTE switch mutes the signal to all busses, including pre-fade Aux sends. The mute circuit can also be activated by the mute group system, a SIP mute signal, a VCA mute signal or internal snapshot control from the scene computer. A Preview mode allows editing and checking of mute groups and snapshots without disturbing the audio passing through the desk, and Mutes can be set 'Safe'.

## LED Input Metering

Every channel is fitted with a 12-segment LED bargraph meter, positioned next to each fader for maximum visibility and giving immediate graphic indication of incoming signals at the Mic amp output. The meter point can be changed to post-fader with internal solder links.

## VCA Assignment

Each channel can be assigned to any combination of 8 VCA subgroups, using the SOLO button on each channel, in conjunction with the VCA Master SOLO switches in VCA Assign mode. Once assigned to a VCA group, the channel's fader level, mute and solo button come under the control of the VCA master controls, but can still be operated locally.

## SOLO

The Solo button provides a PFL feed to the engineer's headphones or monitors, or triggers a destructive solo in place, depending on mode selection at the master section. The solo button can also be activated remotely from a VCA solo when assigned to a VCA group, giving Stereo AFL. Intercancel or additive soloing is possible, with or without input priority, and solos can be cleared with a single button press at the master section.

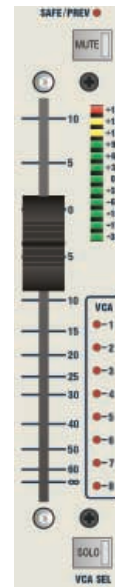

# Stereo Input Module

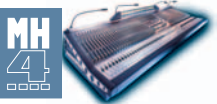

**Four stereo input modules are fitted as standard to all frame sizes, but more can be added by replacing mono channels.**

**The integral backpanel and common fader panel mean that individual stereo inputs can be fitted anywhere within the input section of the console.**

## Input stage

The same new high performance pre-amp offers the same gain range of +15dBu to +60dBu with Phantom Power switching and polarity reverse on the left channel. The peak LED indicates signals in excess of +18dBu, while two MONO switches cut either Left or Right channel, feeding the alternate channel to both module paths, or if both are pressed a mono sum of L and R to the module paths.

## Balanced Insert Points with INS switch

Separate jacks provide a pre-EQ balanced send and return, at a nominal level of 0dBu. The INS switch switches the insert return into the signal path. The insert send is always active, even when INS is not on.

## EQ and HI-PASS Filter

This new design incorporates the same design enhancements as the Mono channel. The High-pass filter is fixed at 80Hz, with bypass if required.

The EQ section is stereo four band, with sweepable frequencies on all bands.

The frequency ranges are 35Hz-550Hz (LF), 75Hz-1.2kHz (Low Mid), 750Hz-12kHz (High Mid), and 1.2kHz-20kHz (HF), with +/-15dB of cut or boost available at any frequency. The Q is fixed on the two mid bands at 1.3, with shelving response on the LF and HF bands.

## Mono Aux Sends

There are 8 dedicated mono Aux sends, switchable pre or post fader in pairs, with internal links selecting the pre-fader signal to be pre- or post-EQ (both feeds follow the channel mute). These are intended as FX sends in FOH use, or mono mixes for monitoring. Each send has 5dB of gain at maximum. Each send is fed from a mono sum of the module L and R signals.

## Groups and Stereo Aux sends

As on the mono input, the Global GRP switch determines the use of the stereo auxes in FOH or Monitor mode.

## 'Monitor' Mode - Global GRP mode NOT SELECTED

In this mode the four dual concentric sends function as Aux sends 9-16. These are mono/stereo switchable in banks (A9-A12 & A13-A16). Up to 16 mono auxes can be configured while stereo auxes are ideal for use as In-Ear or stereo wedge sends. Adjacent PRE switches allow the source for the sends to be switched Pre- or Post- fader in pairs, with the pre-fade feed following the pre/post-EQ internal link settings (default = post-EQ). In mono mode, each send is fed from a mono sum of the module L and R signals. In stereo mode, the module left side is sent to the odd-numbered busses, and the right to even, with gain of 5dB at max. The L-R balance to the bus pairs is controlled by the main channel balance control.

In this mode, the adjacent routing switches 1-2, 3-4, 5-6 and 7-8 will not function.

## 'FOH' Mode - Global GRP mode SELECTED

In this mode the busses which are used in Monitor mode for Auxes 9-16, now become Subgroup busses, with fixed routing via the 1-2, 3-4, 5-6, 7-8 switches. The left module signal is fed to the odd-numbered busses, and the

right to even. The L-R balance to the bus pairs is controlled by the main channel balance control.

As a bonus in FOH mode, the send upper level pots become an additional 4 mono Aux sends, numbered A17, 18, 19 and 20. These are fed with a mono sum of the module signal, and can be switched pre- or post-fader by the associated PRE switches. The masters for these sends are rotary controls located on the Stereo Group module.

## Routing and Balance

The signal is sent to the stereo mix bus and the mono bus using the MIX and C switches.

The BAL control allows the left signal to be faded down to zero level when turned fully clockwise, and vice-versa for the right signal. In the centre position, both channels are fed at unity gain to the Mix bus. The balance control also affects the signal balance to the stereo Aux sends or group busses, as described above.

The C (mono) bus is always fed directly with a mono sum of the stereo post-fader signal.

## Fader

A high-quality long-throw 100mm fader controls the level to all busses, and has 10dB of gain when fully up as well as an expanded scale around the critical unity gain area for maximum resolution.

## MUTE

The MUTE switch mutes the signal to all busses, including pre-fade Aux sends. The mute circuit can also be activated by the mute group system, an SIP mute signal, a VCA mute signal or internal snapshot control from the scene computer. A Preview mode allows editing and checking of mute groups and snapshots without disturbing the audio passing through the desk, and Mutes can be set 'Safe'.

## LED Input Metering

Every channel is fitted with a 12-segment LED bargraph meter, positioned next to each fader for maximum visibility and giving immediate graphic indication of incoming signals at the Mic amp output (highest of left and right signals is displayed). The meter point can be changed to post-fader with internal links.

## VCA Assignment

Each channel can be assigned to any combination of 8 VCA subgroups, using the SOLO button on each channel, in conjunction with the VCA Master SOLO switches in VCA Assign mode. Once assigned to a VCA group, the channel's fader level, mute and solo button come under the control of the VCA master controls, but can still be operated locally.

## SOLO

The Solo button provides a stereo PFL feed to the engineer's headphones or monitors, or triggers a destructive solo in place, depending on mode selection at the master section. The solo button can also be activated remotely from a VCA solo when assigned to a VCA group, giving Stereo AFL. Intercancel or additive soloing is possible, with or without input priority, and solos can be cleared with a single button press at the master section.

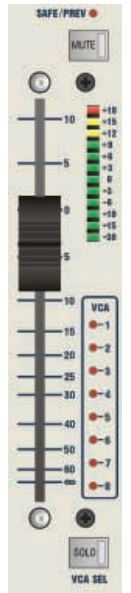

# Output Section - Overview

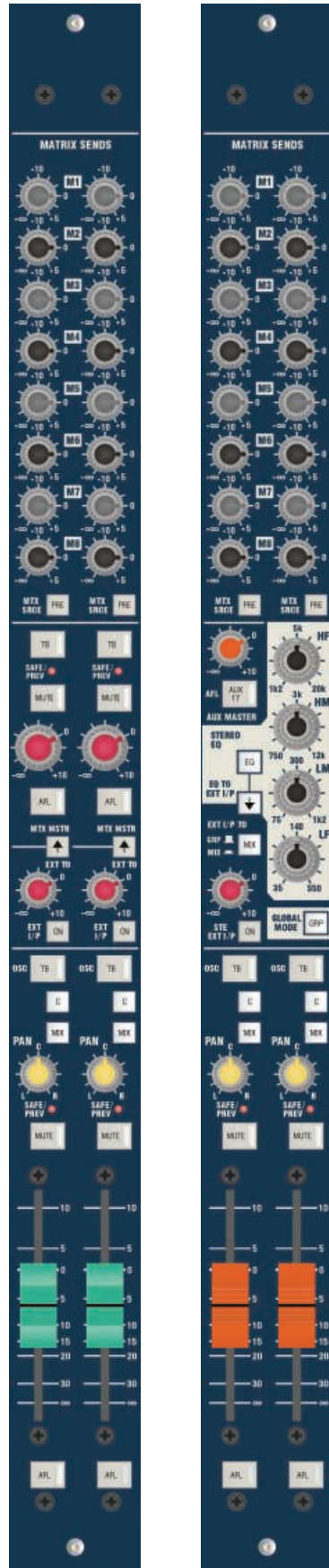

The Output Section is made up of eight 2-way Output modules, giving control of the 16 output busses plus the additional 4 Aux busses (which are only available in GRP mode). The fader panel below these output modules contains the 8 VCA master faders.

The layout of the output section is clear and offers excellent flexibility as well as numerous facilities. The first four 2-way modules control the 8 mono Aux outputs, plus the 8 Matrix master controls. The second four 2-way modules control the 8 dual-function Grp/Aux outputs, and have stereo 4-band EQ, for in-ear Monitor applications, instead of the Matrix outputs. All output fader knobs are colour coded to match their corresponding input sends, for maximum clarity.

The upper section of both types of module contain sends to the 8 outputs of the powerful 20x8 matrix, which accepts feeds from the 8 mono auxes, the 8 dual-function Grp/Aux busses, the MIX L, R and C busses, and an external input if desired.

## Dual Aux Output Module

### External input

A 1/4" jack on the rear panel allows a balanced line level signal to be directly connected to the aux busses for connection of a slave console or other source. These inputs can be switched on or off, and level controlled, on the module.

### Matrix sends

Each output has level controls to derive 8 individual mixes to the 8 matrix busses, with matrix master level control, AFL and mute for each output on these modules. The external input can also be routed to the matrix, and along with the auxes and group/auxes make up a powerful 20x8 matrix section. All matrix outputs are on balanced XLR connectors. Each matrix output has a pre-fade insert and uses balanced sends and returns, via separate 1/4" jacks on the rear connector panel (return jack normalised).

### Aux master faders

Each of the 8 mono aux outputs is controlled by a 60mm fader, with 10dB of gain at maximum, to a balanced XLR on the rear panel, and each fader knob is colour co-ordinated with its aux bus send controls for easy identification. Each aux master section is equipped with PAN, AFL solo and MUTE controls, with individual routing to MIX and C busses. The TB button on each output routes talkback, tone or pink noise from the central talkback/oscillator section to the aux output. Each Aux module features a balanced insert point on the rear panel, via separate 1/4" jacks.

## Stereo Grp/Aux Output Module

This has identical matrix sends, insert and external input facilities as the Dual Aux module, but additionally has 4 band semi-parametric stereo EQ on the Grp/Aux outputs. The global Grp/Aux switching determines the mode of the 8 Grp/Aux busses in FOH or Monitor mode as described in the input module section.

### EQ

Indispensable when feeding in-ear monitors, the four-band stereo EQ features the same circuit and features as found on the stereo input module with frequency bands of 35Hz-550Hz (LF), 75Hz-1.2kHz (Low Mid), 750Hz-12kHz (High Mid), and 1.2kHz-20kHz (HF), with  $\pm 15$ dB of cut or boost available at any frequency. The Q is fixed on the two mid bands at 1.3, with a shelving response on the LF and HF bands. The EQ can be switched into the external input path if required to allow additional equalisation of slave console master feeds, or FX Returns.

### Aux outputs A17-A20

This module also incorporates the master level and AFL controls for the 4 mono aux outputs derived from the stereo Aux upper send controls when the console is used in FOH mode.

### External Inputs

A 1/4" jack on the rear panel allows a balanced line level signal to be directly connected to the Grp/Aux busses for connection of a slave console or other source. These inputs can be switched on or off and level controlled on the module. On this module the external inputs are treated as a stereo pair, and can be routed to the Mix L & R busses instead of the Grp/Aux busses if desired, for use as FX Returns. Each stereo Group module features a balanced insert point on the rear panel.

# Master Modules & Fader Panel

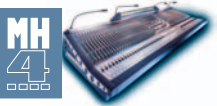

The master modules contain the main L, R and C (mono) output faders, alternate stereo mix output, a noise test or sine wave oscillator, and internal/external talkback functions. There are also matrix sends from the MIX L, R and C busses to each of the 8 fader outputs. The associated section of the fader panel below the master modules contains the monitor and headphone outputs, 2-Track return and monitor source controls. Insert points in the MIX L and R paths use balanced sends/returns on separate 1/4" jacks on the rear panel.

## Main Output Faders

Three 100mm high quality faders control the Stereo Mix Left and Right and Centre (Mono) Mix output levels. These are fed to balanced XLRs on the rear panel. The Centre fader can be used to control the 'Monitors' level for feeding wedges in a stage monitor application by using the 'Fader to Mntrs' button. Three external inputs allow a slave console or other source to be summed onto the MIX L, R and C busses.

## Alternate stereo mix output

The ALT output is an additional stereo output, switchable pre or post the MIX master faders and controlled by the ALT L and R faders. The outputs appear on balanced XLRs on the rear panel. Both L and R outputs can be fed by a mono sum of the MIX L and R signals using the MNO switch, effectively giving two fader controlled mono sum mix outputs.

## Insert Points

Pre-fade MIX L, R and C (mono) insert points use balanced sends and returns on separate 1/4" jacks on the rear panel.

## Talkback and Oscillator section

The talkback and oscillator sections share a common set of routing buttons, allowing them to access any of the console busses. In addition, routing to any matrix output is possible by pressing the TB button on the Matrix Master. The talkback section has a front panel XLR for mic input. The mic signal can be routed either to selected internal busses, by pressing the INT button, or sent to a proprietary intercom output (compatible with Soundcraft Series FIVE and SM Series consoles) using the EXT button. The EXT mode also switches the TB mic signal onto the Clearcom signal line, and any talkback signal being received on the Clearcom line is switched to the headphones, dimming the program by 15dB. The CALL switch is only used for Clearcom talkback, and is a non-latching switch used to switch 10Vdc onto the intercom line. This is used to attract the attention of the remote station and get them to switch on their own 'Talk' switch. Additionally, an incoming 10V call signal will cause the console Littlites to flash, eliminating the need for a separate strobe call lamp.

The oscillator generates either tone from 63Hz to 10kHz or pink noise, and has its own independent balanced XLR output on the rear panel.

## PSU Status Indicators

Three PSU Status Indicator LEDs (red) indicate normal PSU rail operation.

## Monitor and Headphones Outputs

Separate level controls are provided for engineer's monitor speakers and headphones. The signal source for these outputs can be selected from the post-fade MIX signal, the Centre (mono) MIX signal (to both L and R outputs), or the 2TK replay inputs, and may be summed by simultaneous selection if required. These sources are automatically overridden by an input or output solo signal. The L and R switches allow either the left or right side of the monitor signal to be fed to both L and R monitors and headphones. The MUTE affects the monitor outputs but not the headphones. The headphones output socket is a stereo 1/4" jack, discretely mounted in a recessed socket in the fascia.

## 2 Track Replay Input/Record Output

The main stereo MIX signal is fed to a pair of 1/4" jack outputs for 2-track recording, and the Centre output signal may be added to this to allow the recording to pick up the centre feed. For replay, a rotary level control adjusts the sensitivity of the stereo line input from the balanced 1/4" jack 2TK Replay rear panel inputs, which can either be routed to the MIX bus with the MIX switch, or monitored on the monitor/phones outputs as described above.

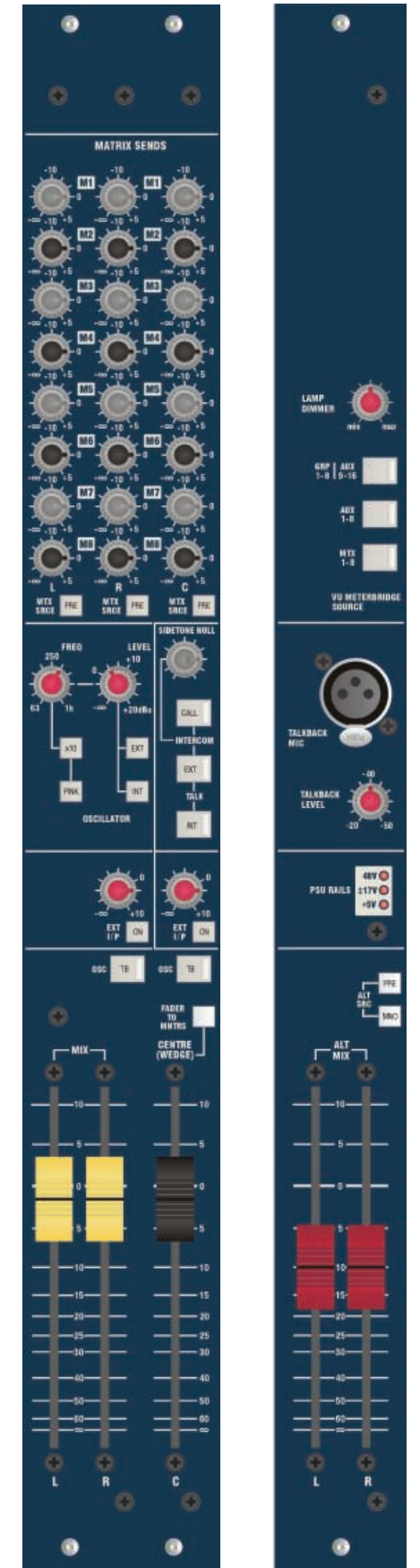

# Logic & Automation

## Solo Controls

The MH4 incorporates an advanced logic-controlled solo system, giving a number of useful features.

The Solo Clear button allows any solo(s) on the console to be cancelled at the touch of a button. The Autocancel mode allows any solo button selected to cancel the previous solo, otherwise solos can be selected additively.

Inputs normally solo as PFL, (with stereo inputs giving a stereo PFL) and Outputs as stereo AFL, but inputs can alternatively be soloed as stereo AFL (if assigned to a VCA group) using the VCA master solo buttons. The PFL/AFL trim control gives  $\pm 15\text{dB}$  of gain adjustment to the PFL or AFL signals fed to the Monitor/phones outputs.

The Input Priority button, when selected, allows an input solo to temporarily override any output solo which may be present. When the input solo is released, the original output solo will reappear on the monitors.

The Solo In Place Enable button (which needs to be held for at least 2 seconds to activate it, for safety) selects destructive in-place solo rather than mono PFL or stereo AFL. Group, Aux and Matrix output solos remain in PFL mode, regardless of this switch setting.

A VCA solo will perform a solo operation on all channels assigned to that VCA group, and give a stereo AFL solo. If SIP mode is engaged, the VCA solo will trigger a solo-in-place solo as if all member channels' SIP switches had been pressed.

## Integrated control of BSS Audio Varicurve/dbx DriveRack

The MH4 continues the Soundcraft innovation of providing remote MIDI control of external system EQ from the Output AFL switches - owners of BSS Audio Varicurve or dbx DriveRack systems can automatically select the correct EQ page on the remote controller, corresponding to the soloed output channel. For Monitor applications, this allows slicker operation and less chance of adjusting the wrong output EQ.



## Metering

A built-in meterbridge of eleven VU meters with integral Peak LEDs monitors the main outputs. Three large VU meters monitor the MIX L, R and C outputs, while eight smaller meters can be switched to monitor the 8 mono aux outputs, the 4 Stereo Grp/Aux outputs, or the 8 matrix outputs. The backlighting uses high-reliability LEDs rather than filament bulbs, with the peak LEDs indicating signals within 3dB of the clipping point.



Standard VU output meterbridge



Optional bargraph output meterbridge

The optional bargraph output meterbridge allows all 16 aux busses to be metered at once, with the Matrix outputs available via bank switching. VU meters are retained for the main MIX outputs.

## VCA System & Automation

The MH4 incorporates an automation system which can memorise and recall 128 snapshot settings of input and output mute status and input VCA assignments, with the ability to send a midi program change message upon recall of a scene, or to recall a scene in response to an incoming program change message. These mute group and VCA group assignments can be recalled manually from the control panel as well as via MIDI, with an LED display indicating the scene number recalled. There is also the facility to insert new scenes between two existing ones. Scene memory can be backed-up using standard Sys-Ex dumps to an appropriate archiving device.

Channels may be assigned to any of 8 VCA Groups using the master Assign Mode switch and the channel SOLO switches. Any VCA master then controls all the associated channel levels and their MUTES and SOLOS (although they can still be operated locally). Similarly, channel MUTES may be assigned to any of 8 mute groups (which can be freely layered) by setting the channel mutes required and pressing STORE and the MUTE master button required. These groups may be recalled by the MUTE MASTER buttons. The Mute Master switches can also be changed to recall any 8 of the scenes in a cue list. To prevent channels being muted by a MUTE GROUP, VCA Mute or a SIP solo, a SAFE mode can be activated for each channel using the EDIT SAFES function. This is indicated locally on each channel by a SAFE LED. A PREVIEW mode allows mute group and scene settings to be checked without actually muting any signal paths.

When two MH4 consoles are linked, the automation and VCA systems of both consoles come under the control of the master, allowing seamless operation. The linking is also compatible with MH3

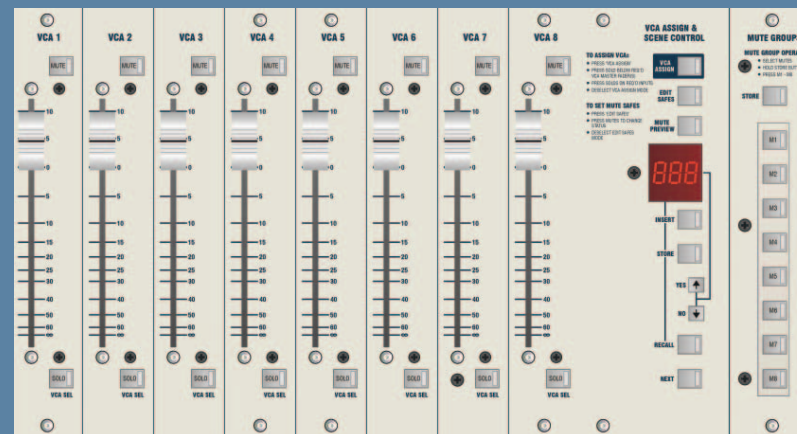

# Dimensions, Rear Panel & Configs

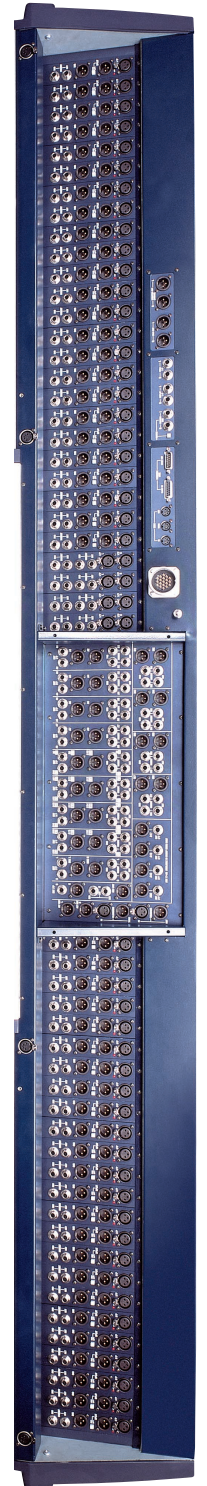
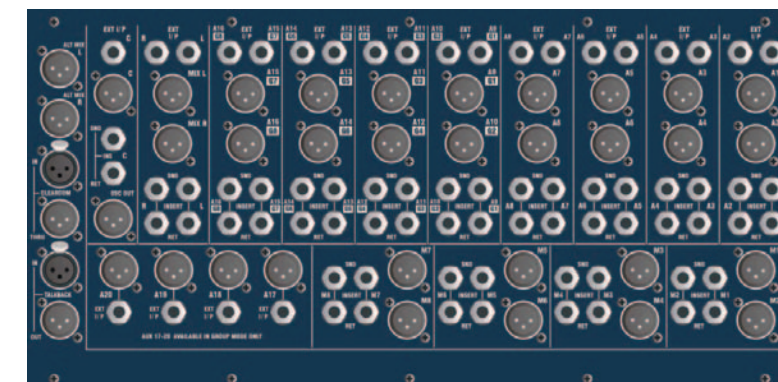
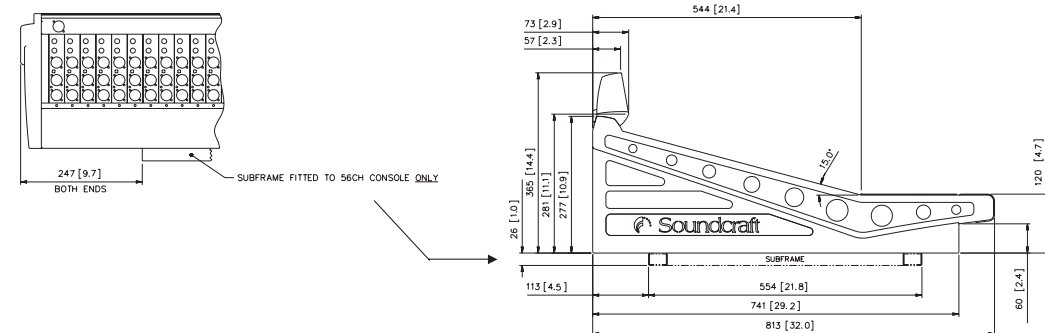
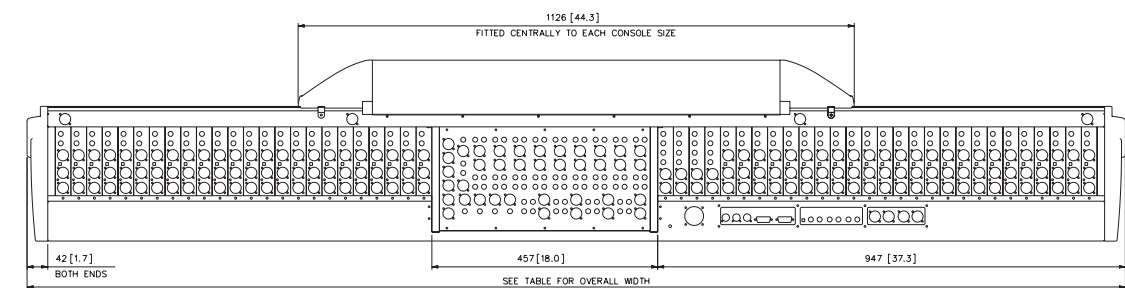
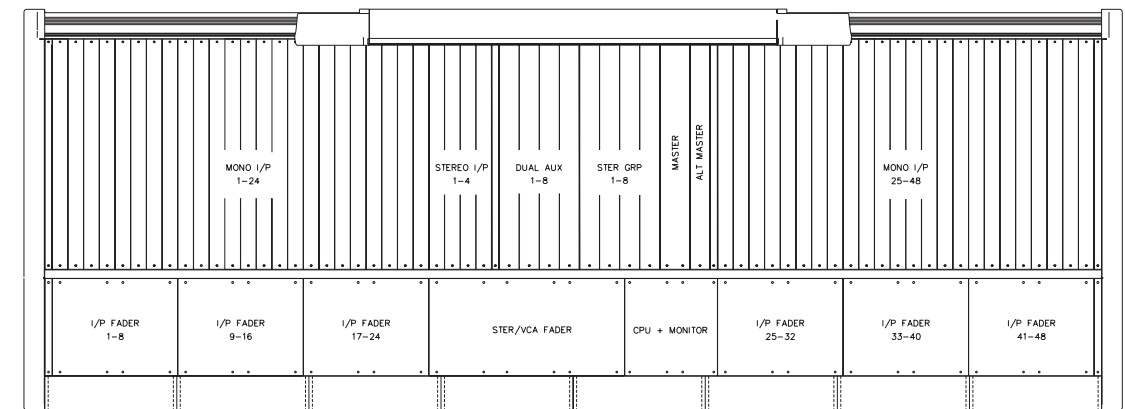

## Dimensions & Weight

Height	All frame sizes	365mm (14.4")	Depth	All frame sizes	813mm (32.0")
Width	24 Ch	1446mm (56.9")	Weight	24 Ch	76 kg (167 lbs)
	32 Ch	1715mm (67.5")		32 Ch	89 kg (196 lbs)
	40 Ch	1969mm (77.5")		40 Ch	102 kg (225 lbs)
	48 Ch	2223mm (87.5")		48 Ch	115 kg (253 lbs)
	56 Ch	2476mm (97.5")		56 Ch	150 kg (557 lbs)

## Flight Case Dimensions (When supplied by Soundcraft)

Frame size	Dimensions (mm)
24 Ch	1525 x 515 x 1260 (h)
32 Ch	1795 x 515 x 1260 (h)
40 Ch	2050 x 515 x 1260 (h)
48 Ch	2305 x 515 x 1260 (h)
56 Ch	2560 x 515 x 1260 (h)

# System Block Diagram

